

Transport Layer

Peler Levinsky, Roskilde IT

28.01.2025

Transport level

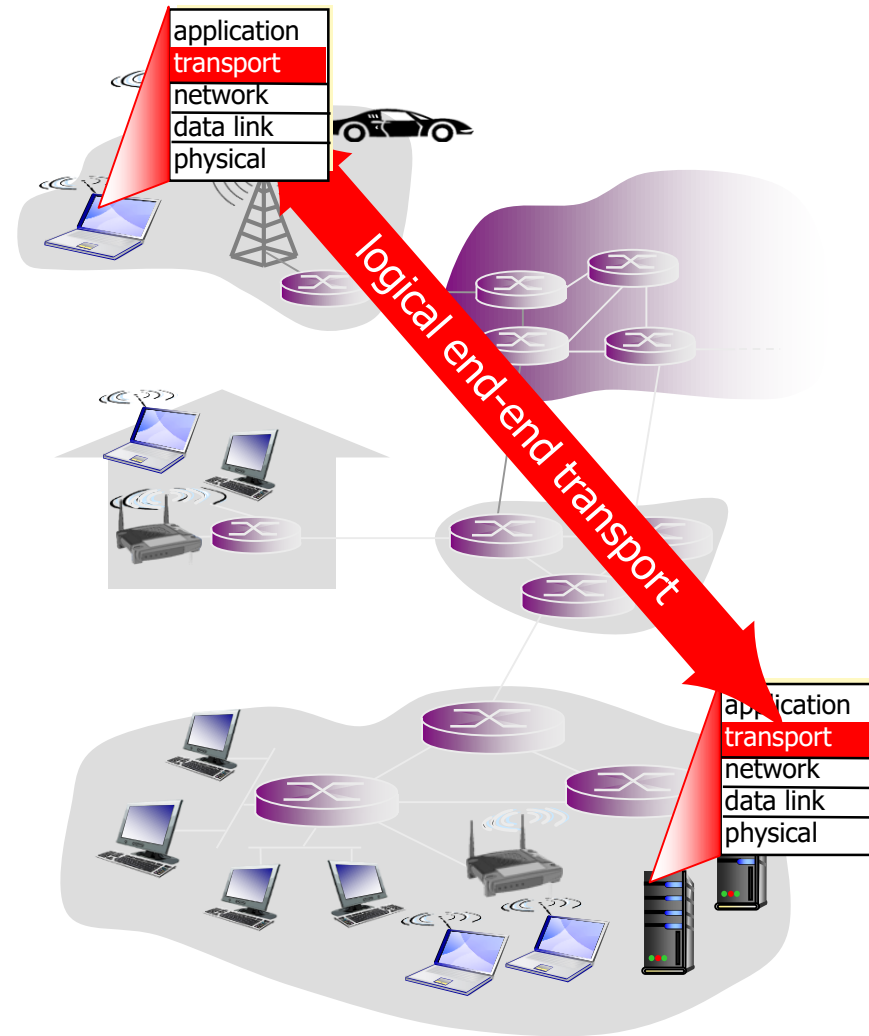

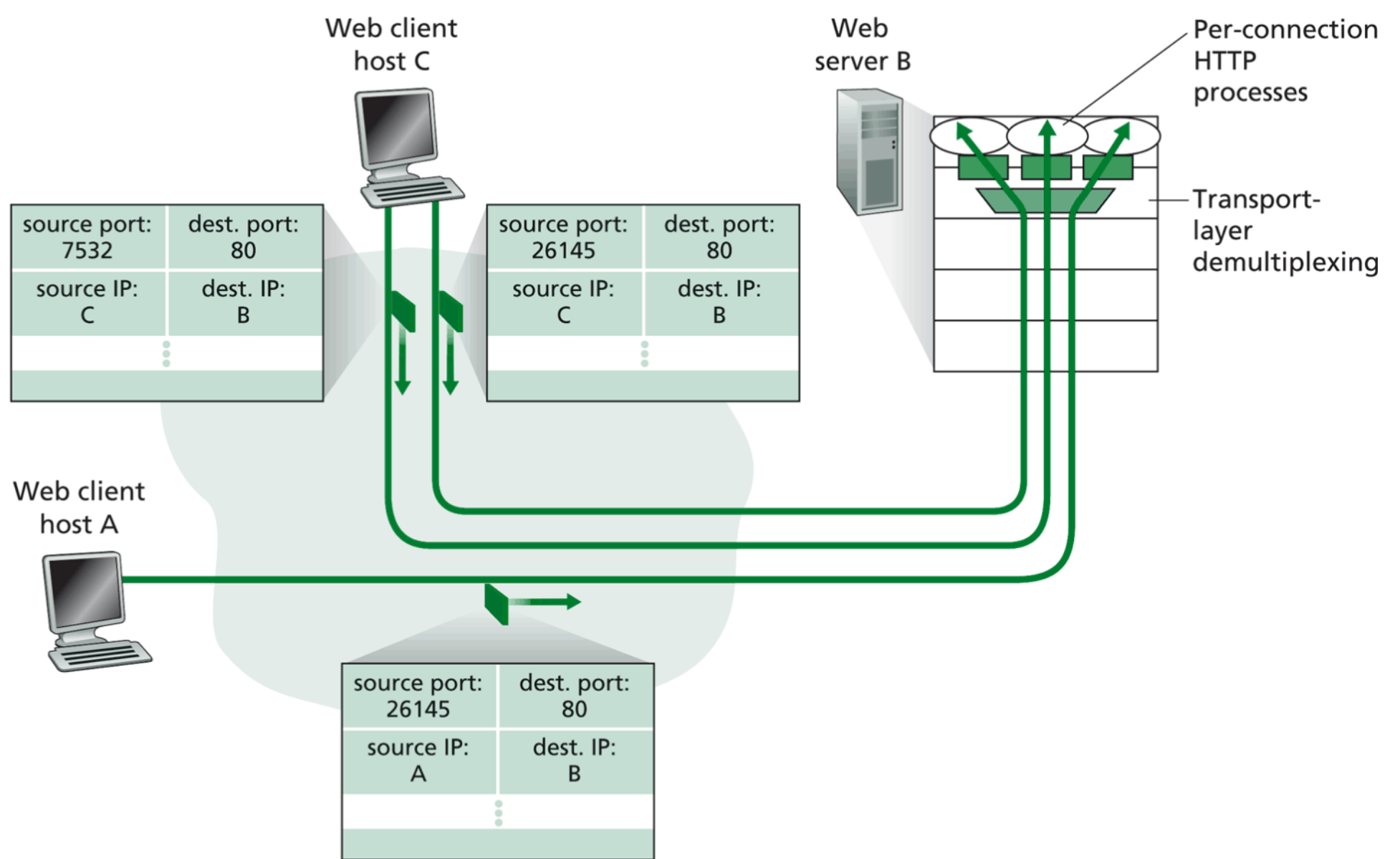
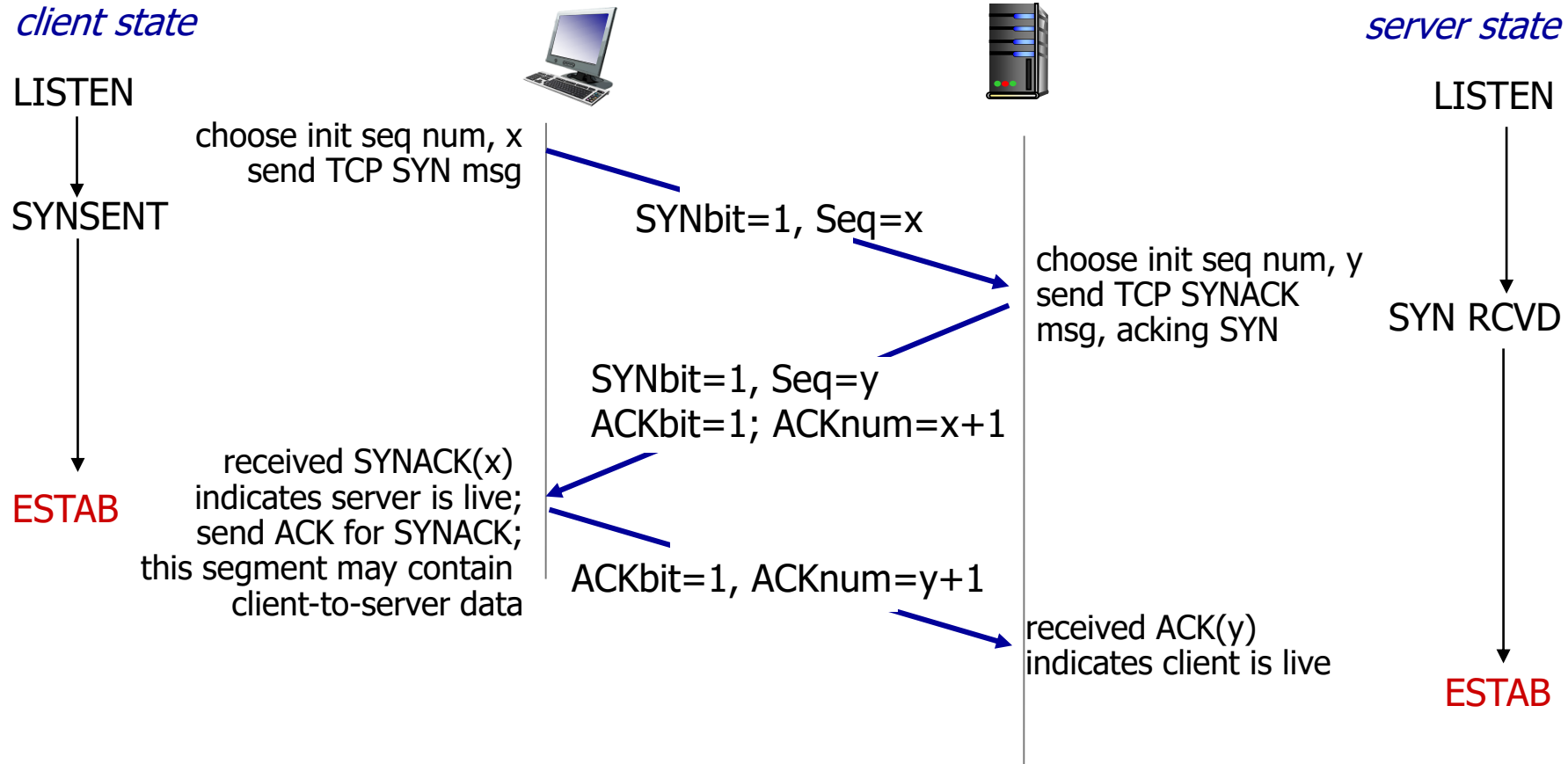
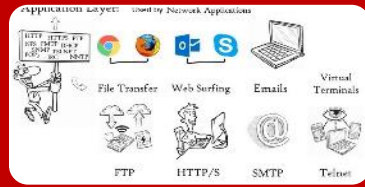

Figure 3.5 ♦ Two clients, using the same destination port number (80) to communicate with the same Web server application

TCP 3-way handshake



Protokolstakken



Application

- Web (HTTP/HTTPS), Email, DNS, DHCP, FTP, ...

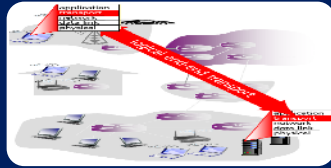

Transport

- TCP - reliable, connection oriented
- UDP - unreliable, connectionless

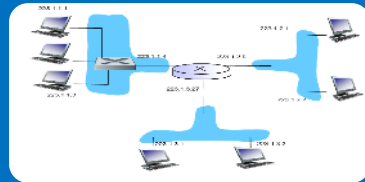

Network

- IP - IP-packets, unreliable
- IP-addresses



Datalink

- All kind of access - Wifi, Bluetooth, Ethernet, ...
- MAC-addresses

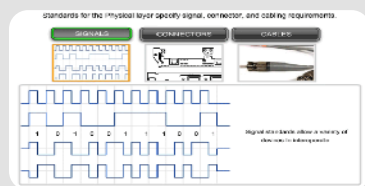

Physical

- Connectors
- Bit encoding/decoding

TCP – Socket - Programming

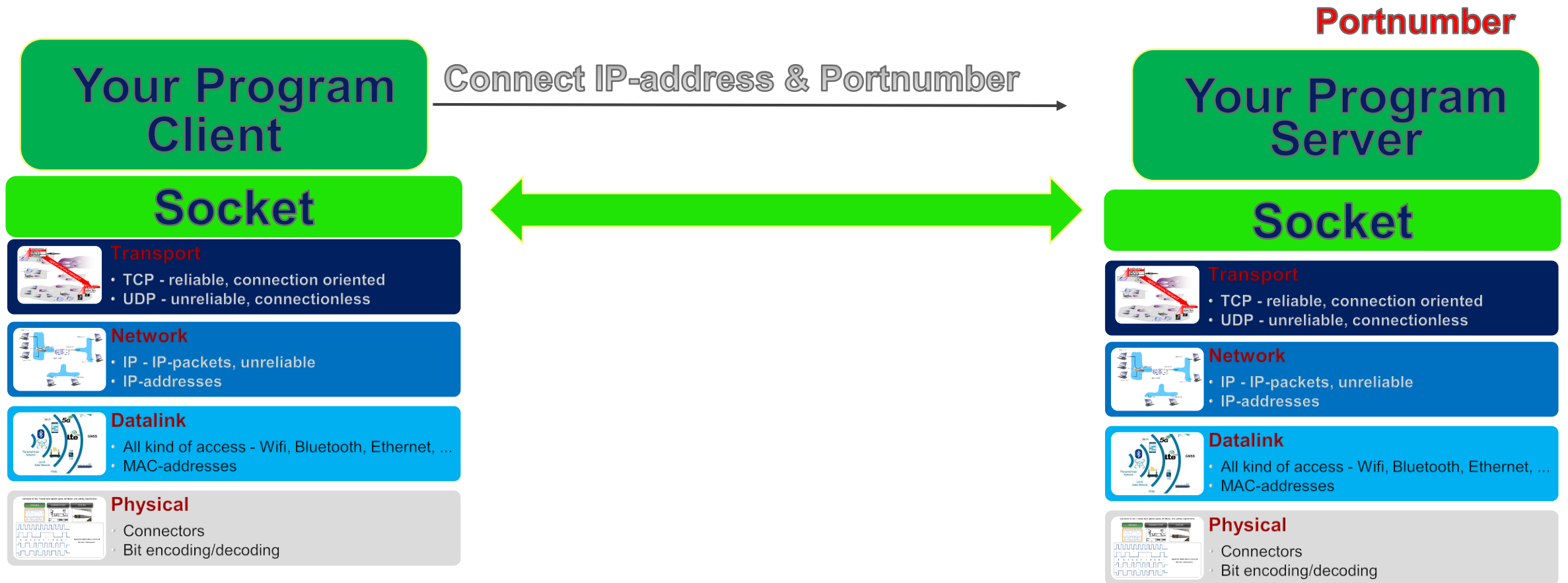

Small Demo – then your turn

