

Network Layer

Peler Levinsky, Roskilde IT

09.11.2022

network layer

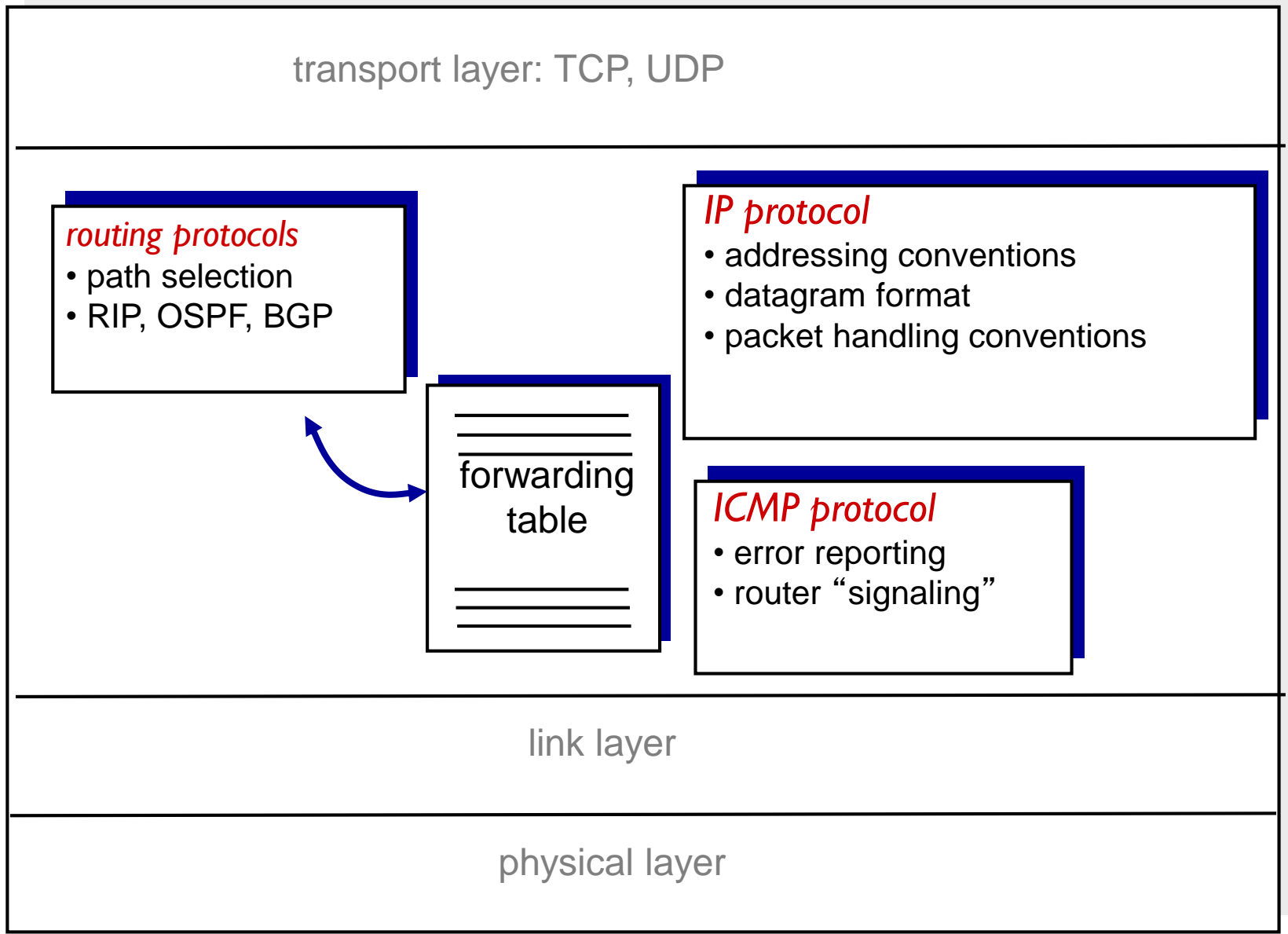

IP Header

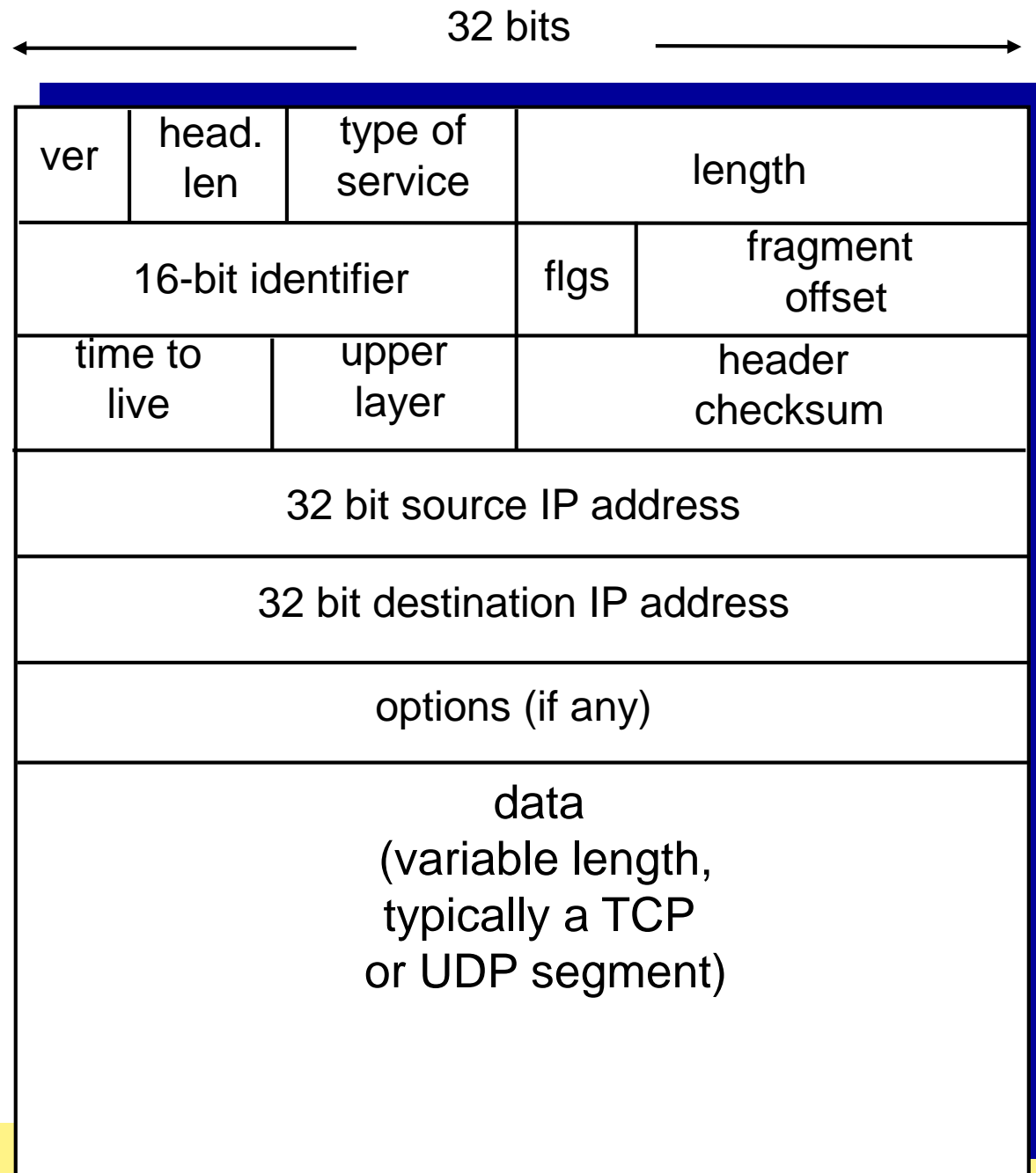

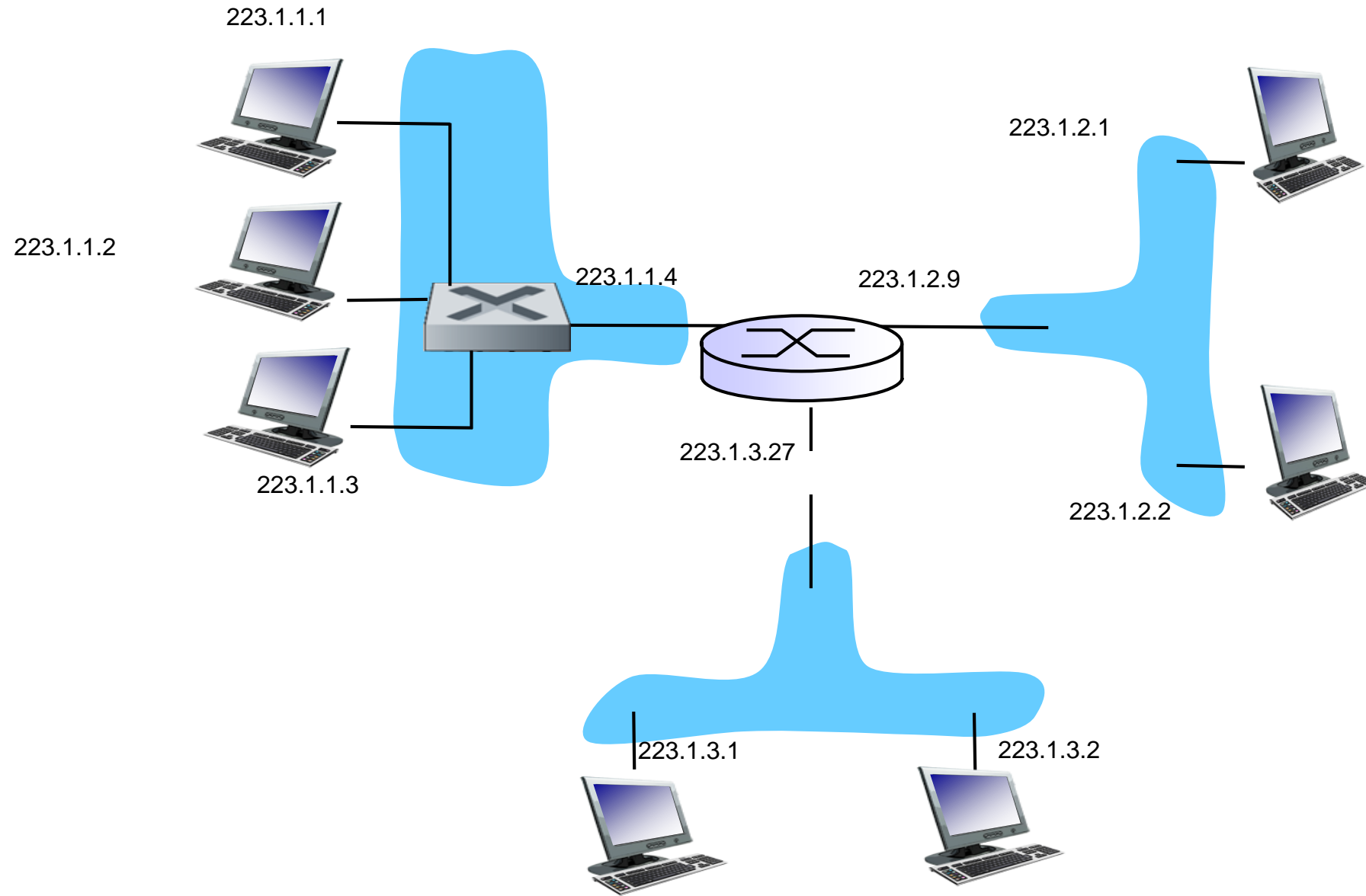

IP Subnet

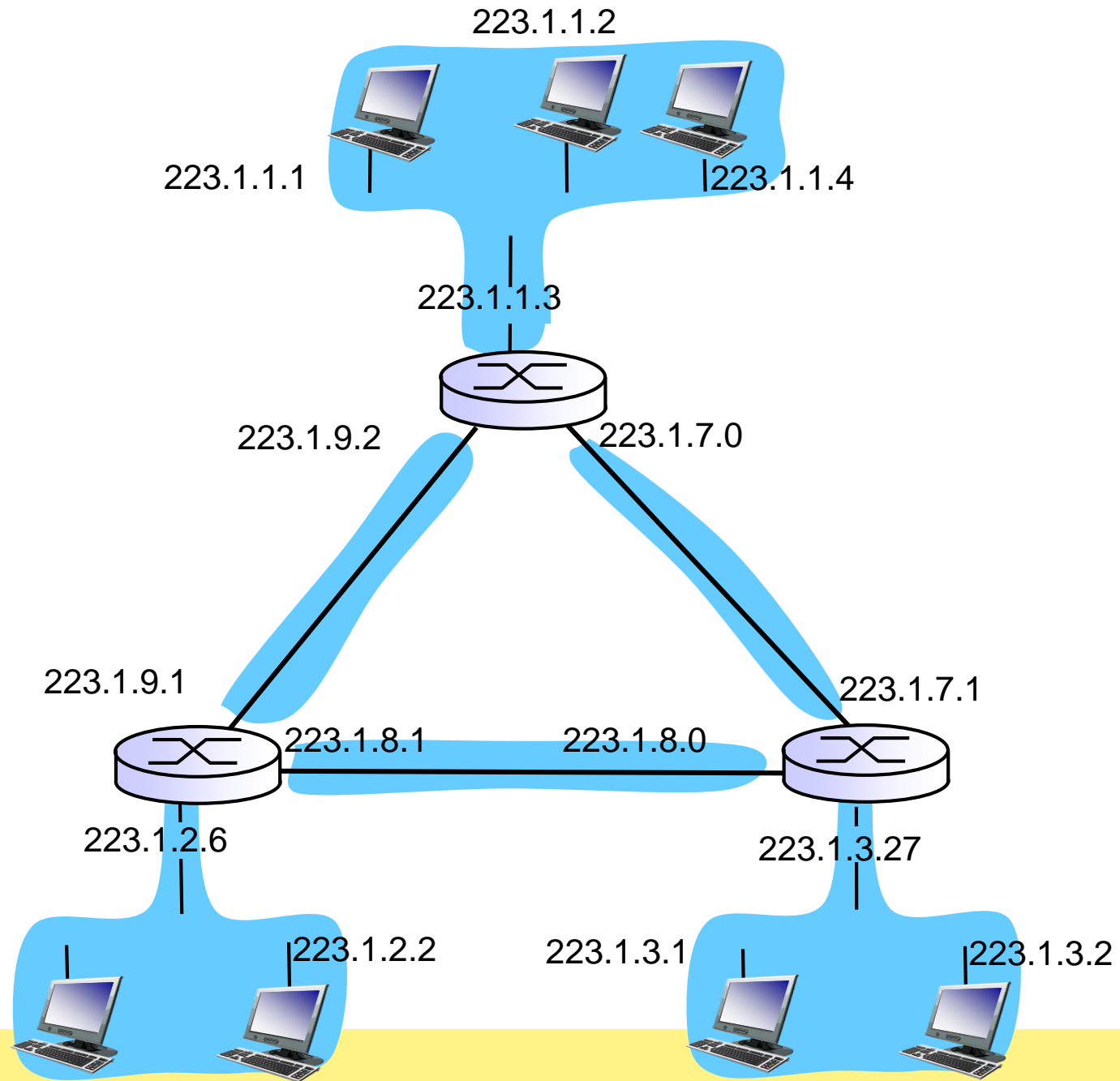

NAT translation table	
WAN side addr	LAN side addr
138.76.29.7, 5001	10.0.0.1, 3345
.....

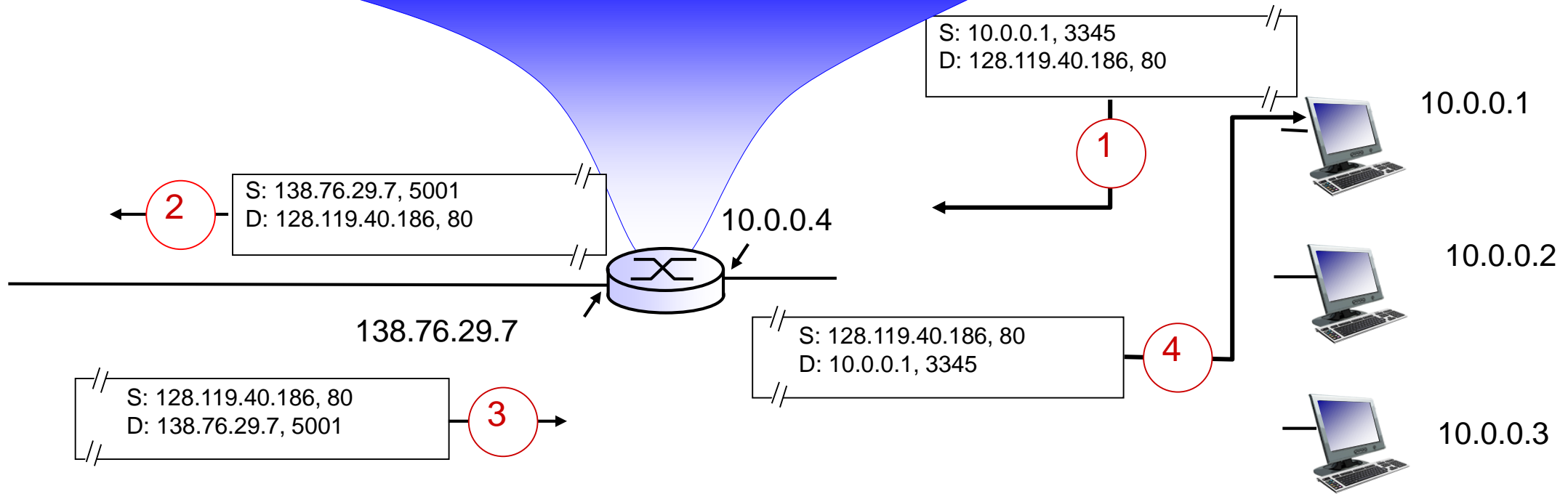

IP Version 6

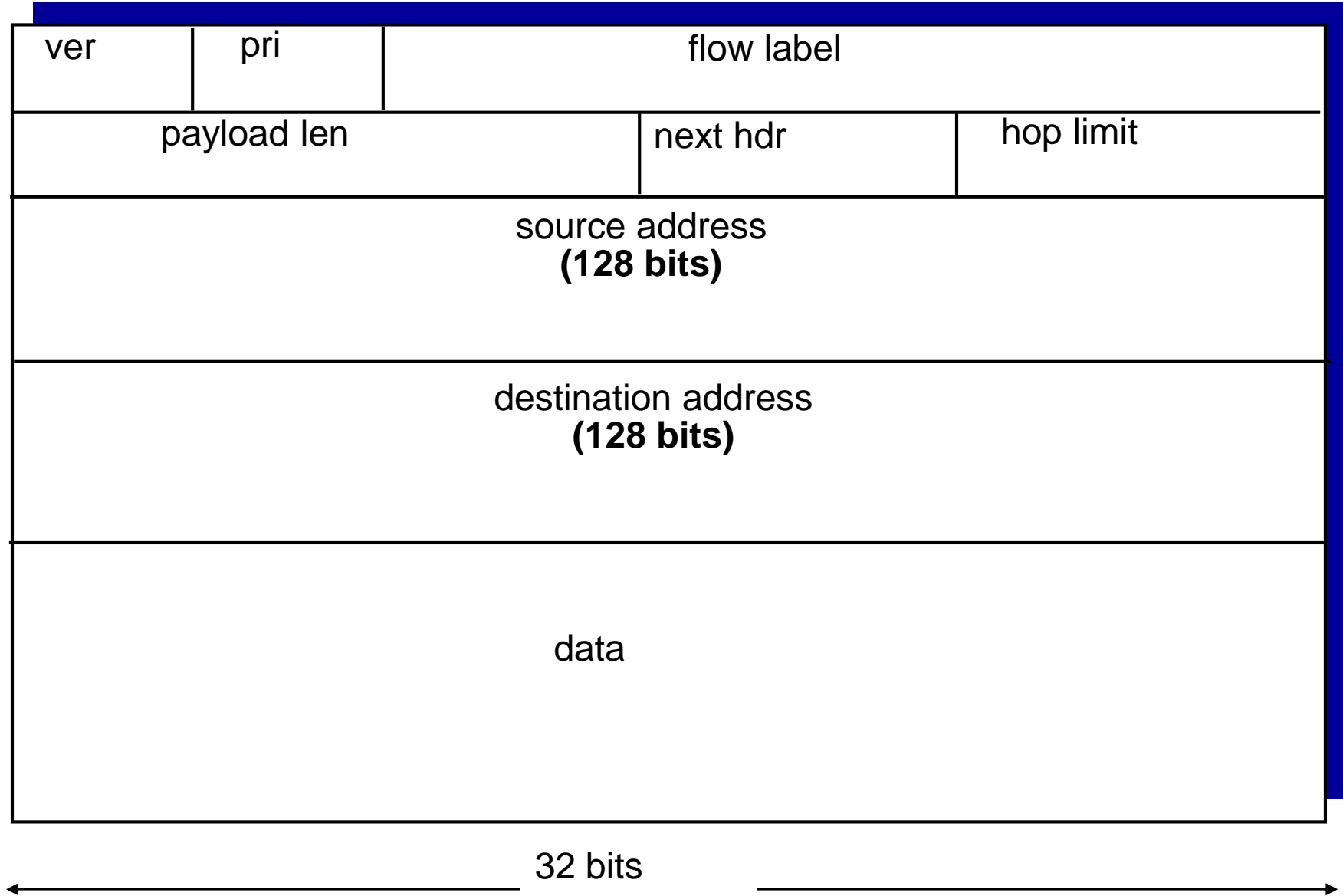

Datalink Layer

Purpose

- ❖ understand principles behind link layer services:
 - error detection, correction
 - sharing a broadcast channel: multiple access
 - link layer addressing (IEEE 802.xx)
 - Framing (Header)
 - local area networks: Ethernet, VLANs

- ❖ instantiation, implementation of various link layer technologies (Ethernet, fast-Ethernet, Wifi, ppp)

Addressing

- **Most protocols => IEEE 802.x standards**
- Media Access Control (MAC) address:
 - function: *used 'locally' to get frame from one interface to another physically-connected interface (same network, in IP-addressing sense)*
 - 48 bit MAC address (for most LANs) burned in NIC ROM, also sometimes software settable
e.g.: 1A-2F-BB-76-09-AD

Address Resolution Protocol (ARP)

	SRC	DEST
IP	111.111.111.111	222.222.222.222
MAC	74-29-9C-E8-FF-55	E6-E9-00-17-BB-4B

	SRC	DEST
IP	111.111.111.111	222.222.222.222
MAC	1A-23-F9-CD-06-9B	49-BD-D2-C7-56-2A

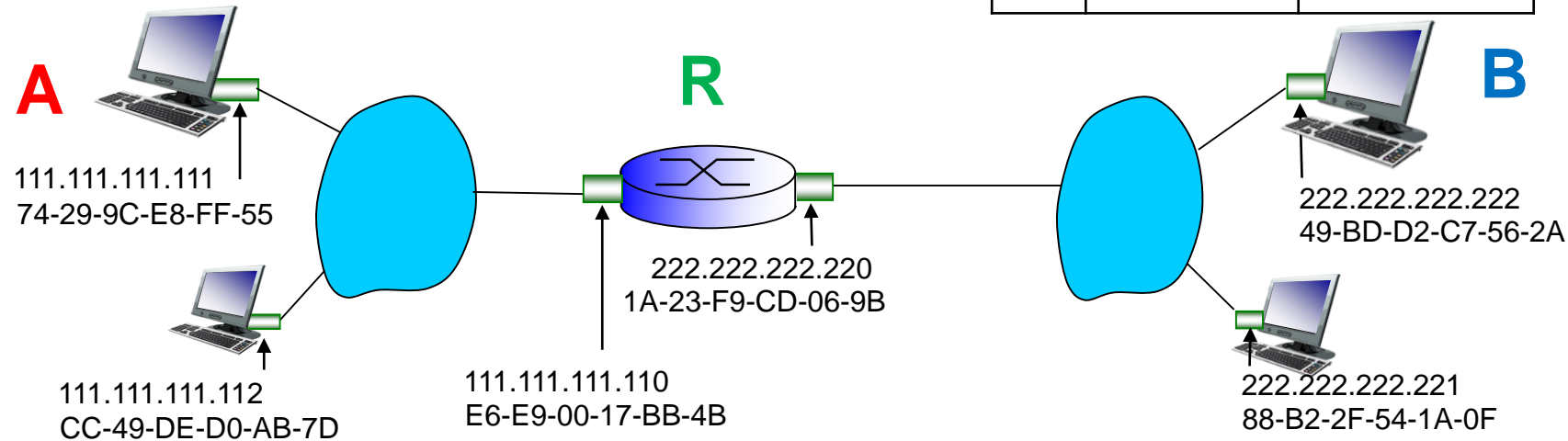

A : arp-broadcast 'Who have 111.111.111.110 ?'

Only R: reply 'I have 111.111.111.110' – which mean on MAC E6-E9-00-17-BB-4B

A: make frame with IP dest 222.222.222.222 and MAC dest E6-E9-00-17-BB-4B

R: arp-broadcast 'Who have 222.222.222.222 ?'

Only B: reply 'I have 222.222.222.222' – which mean on MAC 49-BD-D2-C7-56-2A

R: make frame with IP dest 222.222.222.222 and mac dest 49-BD-D2-C7-56-2A